

DC PM Motor 48V 4500RPM 125W / 430W

65189-547

DESIGN FEATURES

- Replaceable brushes
- Reversible rotation
- Zinc plated corrosion protected housing
- Aluminium/Zinc endshields with ball bearings
- Class F insulation (Max ambient 40°C)
- UL recognised component (E303615)
- Enclosure: IP 54*
- Cooling: IC 410 (TENV)
- Designed to BS 5000-11
BS EN 60034
IEC 60072

* IP rating only applies once B14 is mounted to component

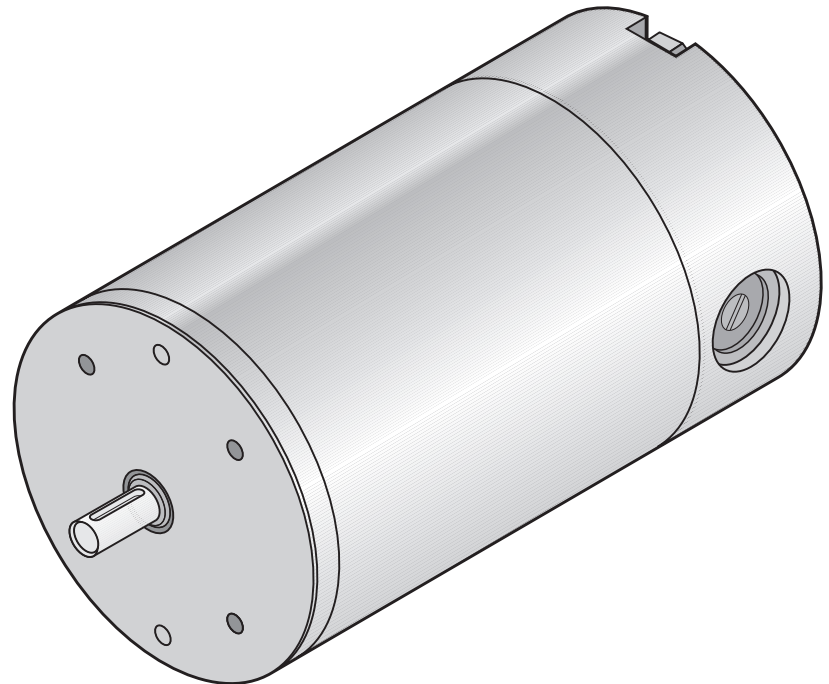

PERFORMANCE DATA

Continuous Rating (S1 Duty Cycle)

Torque (Nm)	0.25
Speed (RPM)	4750
Power (W)	125
Current (A)	4.0

Short-time Rating (S2 Duty Cycle 10min)

Torque (Nm)	0.95
Speed (RPM)	4300
Power (W)	430
Current (A)	12.1

No Load

Speed (RPM)	4900 (+/- 5%)
-------------	---------------

Stall

Torque (Nm)	7.90
Current (A)	92.8

Max Efficiency 74%
Weight 3.5Kg

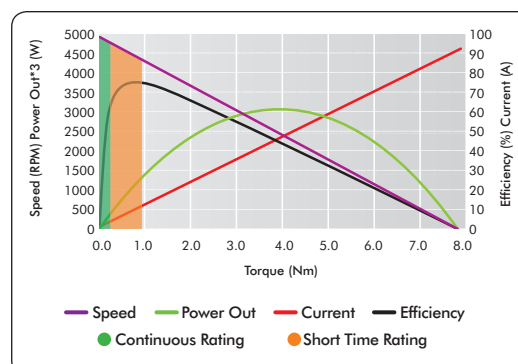
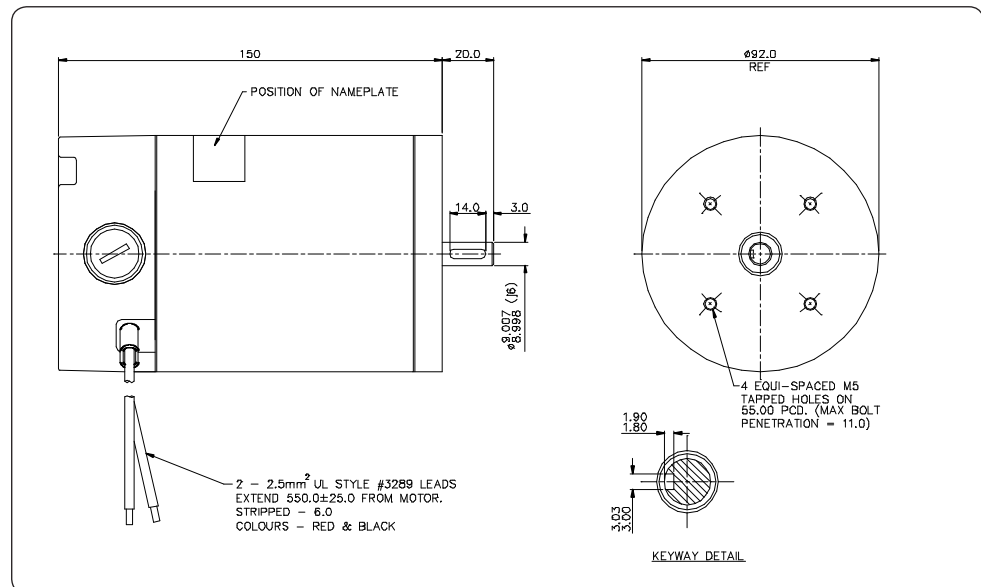

AVAILABLE OPTIONS

- Mounting and connection (Range of standard IEC flanges and bases available)
- Terminal box
- Electromechanical brake (1.5Nm)
- Rear output shaft
- Painted finish
- RFI suppression

www.lemac.com

LOTHIAN ELECTRIC MACHINES LIMITED
HOSPITAL ROAD · HADDINGTON · EAST LOTHIAN · EH41 3PD
TEL: 01620 828700 FAX: 01620 828730
info@lemac.com