

DC PM Motor 48V 3000RPM 400W / 600W

65189-546

DESIGN FEATURES

- Replaceable brushes
- Reversible rotation
- Zinc plated corrosion protected housing
- Aluminium/Zinc endshields with ball bearings
- Class F insulation (Max ambient 40°C)
- UL recognised component (E303615)
- Enclosure: IP 54*
- Cooling: IC 410 (TENV)
- Designed to BS 5000-11
BS EN 60034
IEC 60072

* IP rating only applies once B14 is mounted to component

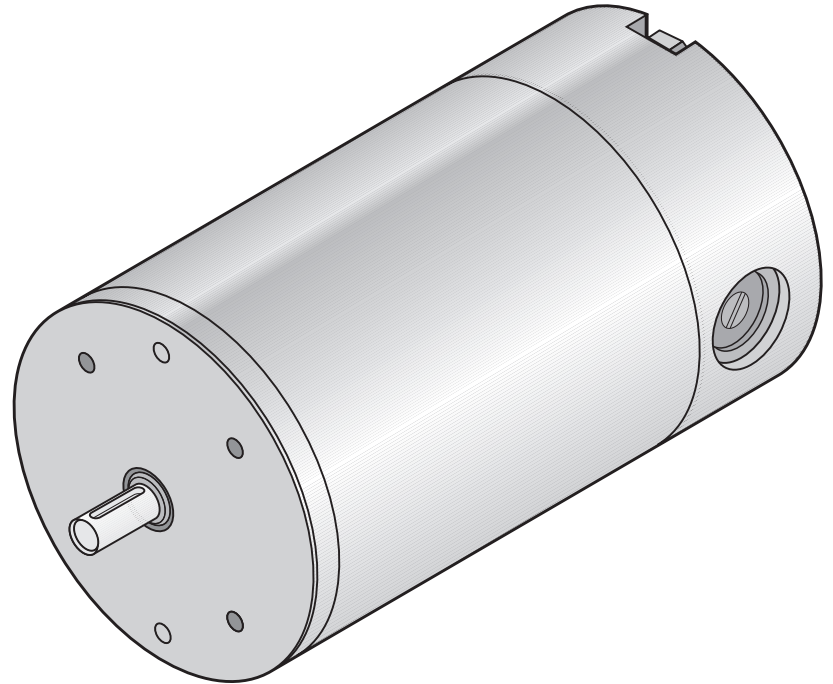

PERFORMANCE DATA

Continuous Rating (S1 Duty Cycle)

Torque (Nm)	1.20
Speed (RPM)	3200
Power (W)	400
Current (A)	10.4

Short-time Rating (S2 Duty Cycle 10min)

Torque (Nm)	2.00
Speed (RPM)	2850
Power (W)	600
Current (A)	17.3

No Load

Speed (RPM)	3700 (+/- 5%)
-------------	---------------

Stall

Torque (Nm)	8.81
Current (A)	75.7

Max Efficiency	86%
Weight	5.3Kg

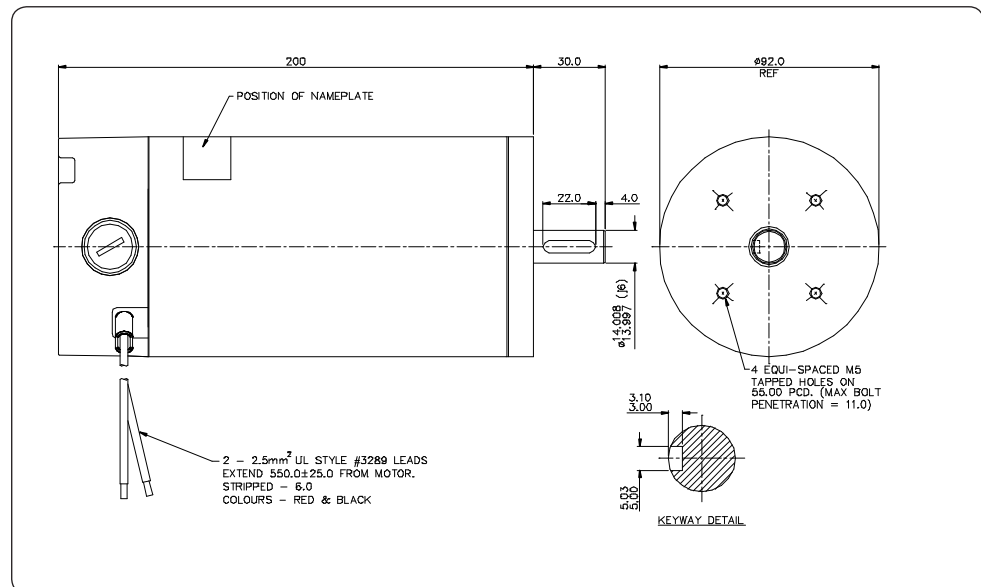

AVAILABLE OPTIONS

- Mounting and connection
(Range of standard IEC flanges and bases available)
- Terminal box
- Electromechanical brake (1.5Nm)
- Rear output shaft
- Painted finish
- RFI suppression

www.lemac.com

LOTHIAN ELECTRIC MACHINES LIMITED
HOSPITAL ROAD · HADDINGTON · EAST LoTHIAN · EH41 3PD
TEL: 01620 828700 FAX: 01620 828730
info@lemac.com