

DC PM Motor 48V 3000RPM 150W / 310W

65189-544

DESIGN FEATURES

- Replaceable brushes
- Reversible rotation
- Zinc plated corrosion protected housing
- Aluminium/Zinc endshields with ball bearings
- Class F insulation (Max ambient 40°C)
- UL recognised component (E303615)
- Enclosure: IP 54*
- Cooling: IC 410 (TENV)
- Designed to BS 5000-11
BS EN 60034
IEC 60072

* IP rating only applies once B14 is mounted to component

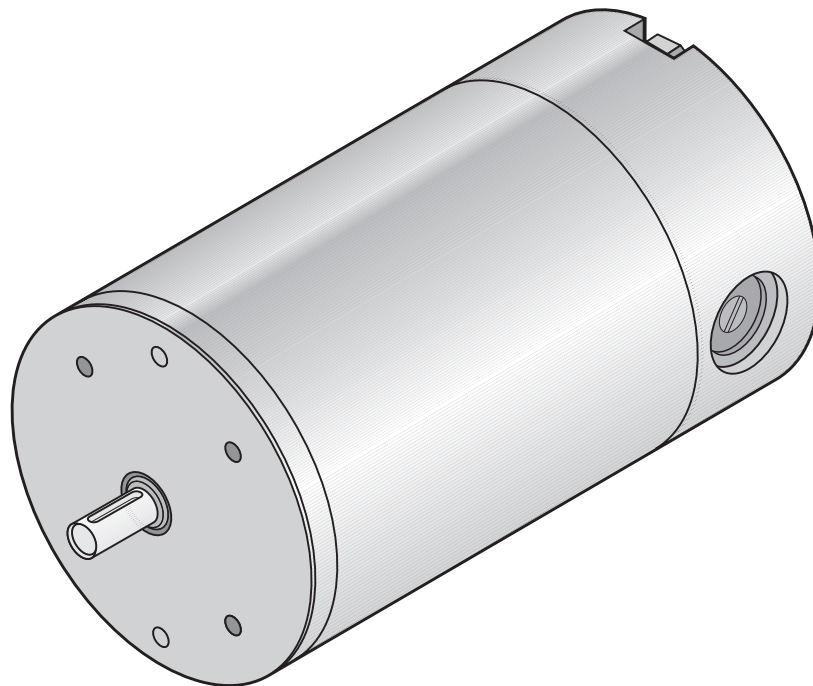

PERFORMANCE DATA

Continuous Rating (S1 Duty Cycle)

Torque (Nm)	0.50
Speed (RPM)	2850
Power (W)	150
Current (A)	4.3

Short-time Rating (S2 Duty Cycle 10min)

Torque (Nm)	1.20
Speed (RPM)	2450
Power (W)	310
Current (A)	9.6

No Load

Speed (RPM)	3150 (+/- 5%)
-------------	---------------

Stall

Torque (Nm)	5.55
Current (A)	42.7

Max Efficiency	73%
Weight	3.5Kg

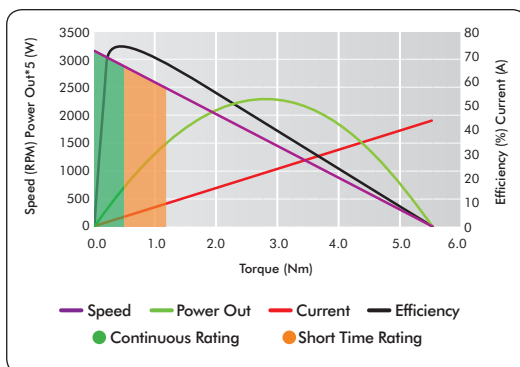
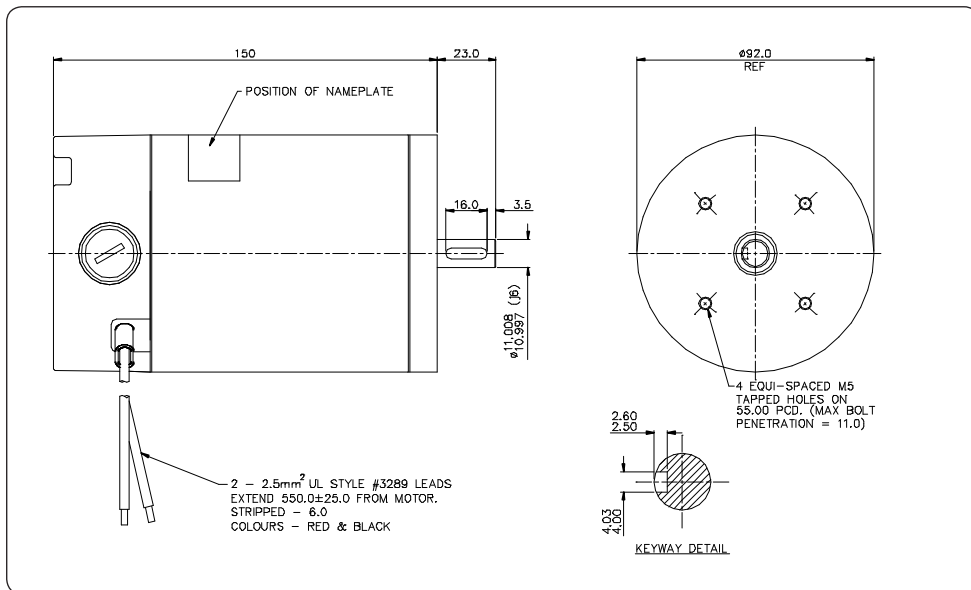

AVAILABLE OPTIONS

- Mounting and connection (Range of standard IEC flanges and bases available)
- Terminal box
- Electromechanical brake (1.5Nm)
- Rear output shaft
- Painted finish
- RFI suppression

www.lemac.com

LOTHIAN ELECTRIC MACHINES LIMITED
HOSPITAL ROAD · HADDINGTON · EAST LoTHIAN · EH41 3PD
TEL: 01620 828700 FAX: 01620 828730
info@lemac.com