

DC PM Motor 12V 3000RPM 90W / 230W

65189-514

DESIGN FEATURES

- Replaceable brushes
- Reversible rotation
- Zinc plated corrosion protected housing
- Aluminium/Zinc endshields with ball bearings
- Class F insulation (Max ambient 40°C)
- UL recognised component (E303615)
- Enclosure: IP 54*
- Cooling: IC 410 (TENV)
- Designed to BS 5000-11
BS EN 60034
IEC 60072

* IP rating only applies once B14 is mounted to component

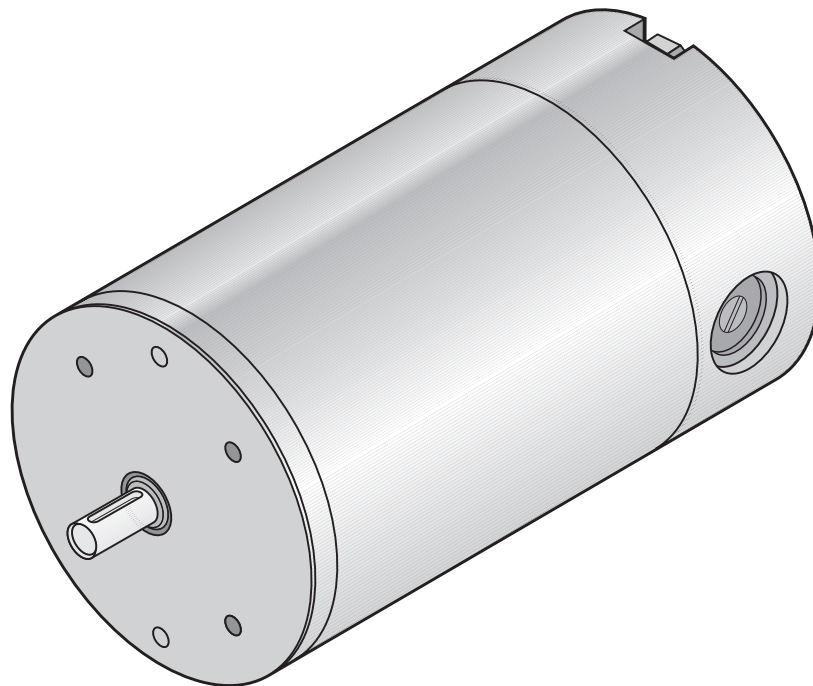

PERFORMANCE DATA

Continuous Rating (S1 Duty Cycle)

Torque (Nm)	0.30
Speed (RPM)	2750
Power (W)	90
Current (A)	11.7

Short-time Rating (S2 Duty Cycle 10min)

Torque (Nm)	0.95
Speed (RPM)	2300
Power (W)	230
Current (A)	32.0

No Load

Speed (RPM)	3000 (+/- 5%)
-------------	---------------

Stall

Torque (Nm)	4.13
Current (A)	131.6

Max Efficiency	64%
Weight	3.5Kg

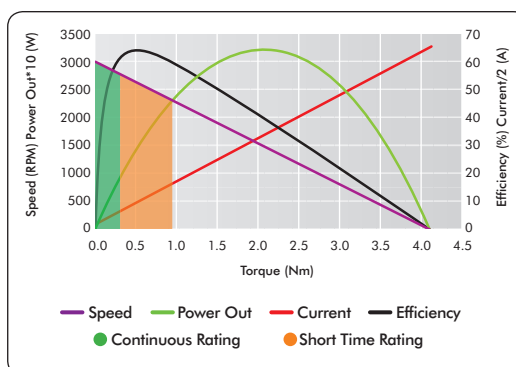
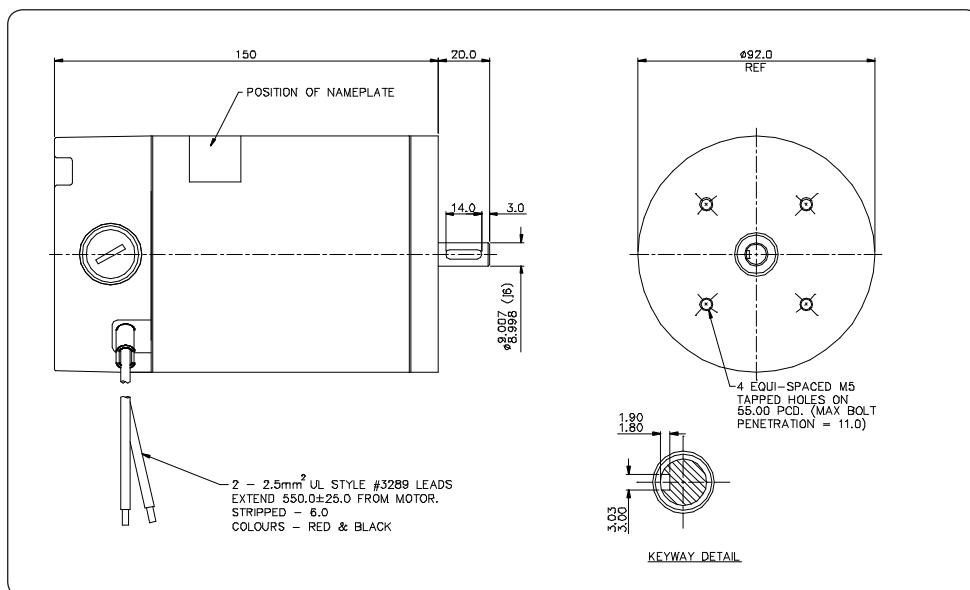

AVAILABLE OPTIONS

- Mounting and connection
(Range of standard IEC flanges and bases available)
- Terminal box
- Electromechanical brake (1.5Nm)
- Rear output shaft
- Painted finish
- RFI suppression

www.lemac.com

LOTHIAN ELECTRIC MACHINES LIMITED
HOSPITAL ROAD · HADDINGTON · EAST LoTHIAN · EH41 3PD
TEL: 01620 828700 FAX: 01620 828730
info@lemac.com